

Zero Tail

Wacker Neuson Zero Tail
50Z3₂ • 75Z3₂

NEW
50Z3₂ OPTIONAL
with VDS



**WACKER
NEUSON**

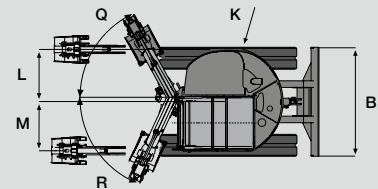
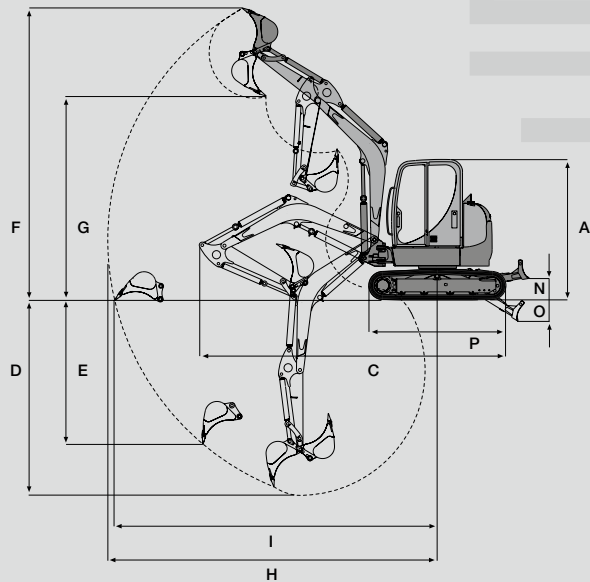

DIMENSIONS:

	50Z32	75Z32
A Height	2570 mm	2670 mm
B Width	1990 mm	2300 mm
C Transport length (arm lowered)	5500 mm	6480 mm

EXCAVATING DATA (BUCKET ARM SHORT/ LONG)







	50Z32	75Z32
D Max. excavation depth	3500 / 3750 mm	4030 / 4320 mm
E Max. vertical insertion depth	2670 / 2885 mm	3400 / 3700 mm
F Max. insertion height	5300 / 5460 mm	6630 / 6820 mm
G Max. cutting height	3680 / 3840 mm	4500 / 4690 mm
H Max. excavating radius	5985 / 6225 mm	7070 / 7350 mm
I Max. reach on the ground	5860 / 6105 mm	6940 / 7210 mm

EXCAVATING DATA (GENERALLY)

Max. overhang at rear (top part of vehicle turned 90°)	0 mm	0 mm
K Tail turning radius	995 mm	1150 mm
L Max. arm displacement to middle of bucket right side	960 mm	950 mm
M Max. arm displacement to middle of bucket left side	895 mm	770 mm
N Max. lifting height levelling blade above formation	415 mm	485 mm
O Max. scraping depth of levelling blade below formation	455 mm	480 mm
P Length of running gear	2500 mm	2845 mm
Q Max. angle of swivel arm system to the right	61°	63°
R Max. angle of swivel arm system to the left	65°	67°
Max. shearing force	26,6 / 23,5 kN	35,3 / 31,9 kN
Max. breakaway torque	33,8 kN	45,3 kN



LIFTING POWER 50Z32							LIFTING POWER 75Z32								
B	A 2 m		3 m		4 m		max.	B	A 2 m		3 m		4 m		max.
	0°	90°	0°	90°	0°	90°			0°	90°	0°	90°	0°	90°	
4,0 m	-	-	-	-	-	-	1060* 810	4,0 m	-	-	-	-	1865* 1505	1795* 920	
3,0 m	-	-	-	-	1010*	780	1025* 585	3,0 m	-	-	-	-	2130* 1425	1760* 765	
2,0 m	-	-	1580*	1150	1185*	730	1045* 490	2,0 m	-	-	-	-	2535* 1290	1760* 690	
1,0 m	-	-	2225*	990	1415*	670	1090* 455	1,0 m	-	-	-	-	2885* 1170	1775* 665	
0,0 m	-	-	2435*	920	1555*	625	1145* 460	0,0 m	-	-	4415*	1630	2995* 1105	1795* 675	
-1,0 m	4070*	1790	2290*	915	1510*	610	1210* 515	-1,0 m	5680*	3485	3990*	1650	2840* 1090	1800* 745	
-2,0 m	3000*	1860	1780*	950	-	-	1255* 705	-2,0 m	4560*	3585	3215*	1715	2345* 1125	1740* 915	



	50Z3₂	75Z3₂
 OPERATING DATA		
Operating weight	5280–6580 kg	7820–9240 kg
Transport weight	4905–6205 kg	7450–8870 kg
 ENGINE		
Manufacturer / type	Yanmar 4TNV88	Yanmar 4TNV98
Type	water cooled 4-cylinder diesel engine EPA III	water cooled 4-cylinder diesel engine EPA III
Engine performance as ISO	28,1 kW (38,2 PS)	43,7 kW (58,5 PS)
Capacity	2189 cm ³	3318 cm ³
Nominal rotation speed	2400 min ⁻¹	2100 min ⁻¹
Battery	12 V / 88 Ah	12 V / 88 Ah
Volume of diesel tank	83 l	93 l
 HYDRAULIC SYSTEM		
Pump	Double variable- & double hydraulic gear pump	Double variable- & double variable displacement gear pump
Capacity	2 x 57 + 41,4 + 11,7 l/min	73,3 + 73,3 + 62,7 l/min
Operating pressure for work and drive hydraulics	240 bar	260 bar
Operating pressure of turntable	215 bar	215 bar
Hydraulic oil cooler	Standard	Standard
Hydraulic tank capacity	80 l	99 l
 DRIVING GEAR AND SLEWING GEAR		
2 driving speeds	2,7 km/h, 4,6 km/h	3,2 km/h, 5,0 km/h
Climbing ability	30° (58 %)	30° (58 %)
Width of track	400 mm	450 mm
Number of runners per side	4	5
Ground clearance	305 mm	375 mm
Ground pressure	0,28 kg/cm ²	0,35 kg/cm ²
Revolving superstructure revolutions	8,7 min ⁻¹	8,7 min ⁻¹
 LEVELLING BLADE		
Width / Height	1990 / 380 mm	2300 / 500 mm
Levelling blade above formation	415 mm	485 mm
Levelling blade below formation	455 mm	480 mm
 NOISE EMISSION		
Sound level (L_{wa}) as 2000/14/EG	96 dB(A)	98 dB(A)
Sound pressure level (L_{pa}) as ISO 6394	77 dB(A)	77 dB(A)

A Projection from the middle of the turntable

B Load sling height above ground level

* Lifting force is restricted hydraulically. All values in the table are given in kg, standing horizontal on hard ground and without bucket. When a bucket or other working tool is attached, the lifting power or tipping load is reduced by their own weight.

Basis of calculations: as per ISO 10567. The lifting power of the compact excavator is limited by the adjustment of the pressure control valve and by the tipping security. Neither 75 % of the static tipping load nor 87% of the hydraulic lifting power is exceeded.

0°		with levelling blade support in direction of travel
90°		without levelling blade support 90° to direction of travel

STANDARD EQUIPMENT50Z3₂ • 75Z3₂**GENERAL****Rubber**50Z3₂ 400 mm75Z3₂ 450 mm**Dozer blade****Working light mounted to the boom****Tool kit incl. grease gun and operator manual****ENGINE****Water-cooled YANMAR diesel engine**75Z3₂ **Automatic idling****CANOPY**50Z3₂ Adjustable driver seat with imitation leather cover and safety belt, canopy complies with the current ROPS, TOPS and FOPS* regulations**CABIN**75Z3₂ **Safety glass cabin:** Tilttable cabin, cabin heating, side sliding window, top swings back, windscreen wiper and washing system, covered cab interior, cabin complies with the current ROPS, TOPS and FOPS* regulations**Cabling** for radio incl. aerial and speakers**Cabling** for cab lighting and flashing beacon**HYDRAULIC****Summation regulation****Hydraulic pilot control** via joystick**Valve control according** to ISO, DIN, SAE, PCSA and EURO**Auxiliary hydraulic connection** for two directions of motion, mounted on dipperstick**Auto2-Speed transmission**, dual travel speed operated automatically, 2nd gear manually locked**Hydraulically dampened drive pedals****Hydraulic oil cooler****Increased, depressurized return line** (for several attachments)

* FOPS (Level I or II) compliant only when fitted with additional protective guard, available as a factory-installed option or as a retrofit kit.

OPTIONS50Z3₂ • 75Z3₂**CABIN**50Z3₂ **Safety glass cabin:** Tilttable cabin, cabin heating, side sliding window, top swings back, windscreen wiper and washing system, covered cab interior, cabin complies with the current ROPS, TOPS and FOPS* regulations**Cabling** for radio incl. aerial and speakers**Cabling** for cab lighting and flashing beacon50Z3₂ 75Z3₂ **Air conditioning system**50Z3₂ 75Z3₂ **Air cushioned seat**50Z3₂ 75Z3₂ **Radio****HYDRAULICS****3rd control circuit** (proport.)**Biological oil Panolin****BP-Biohyd SE46****Flat faced couplers****Proportional control** (aux. hyd)**Addit. piping for grapple****Overload valve for auxiliary hydraulic****Overload system Germany****Overload system France****Prepar. hydraulic QH-system (EASY LOCK)****Pilot circuit Powertilt****PAINTING****Special paint 1 RAL** for parts in yellow only**Special paint 1 non RAL** for parts in yellow only**Special paint cabin RAL**, RAL colours only**MISCELLANEOUS**50Z3₂ **Vertical Digging System (VDS)**75Z3₂ **Hybrid tracks**
(450 mm)**Steeltrack**50Z3₂ (400 mm)75Z3₂ (450 mm), (600 mm)**Cab lighting front****Cab lighting front and rear****Electrical refuelling pump****Flashing beacon**50Z3₂ **Automatic idling****Driving signal****Counterweight**50Z3₂ +300 kg75Z3₂ +400 kg**Long dipperstick**50Z3₂ (+250 mm)75Z3₂ (+300 mm)**Central lubrication system****Security 24 (2000 h)** Warranty extension to 24 months or 2000 operation hours**Security 36 (3000 h)** Warranty extension to 36 months or 3000 operation hours**Drive interlock KAT****PACKAGES****Mirror package**

Exterior mirror right and left

Comfort package

Air conditioning plant, refuelling pump, radio, mirror package, cab lighting front and rear